

# Komplettmaschinen

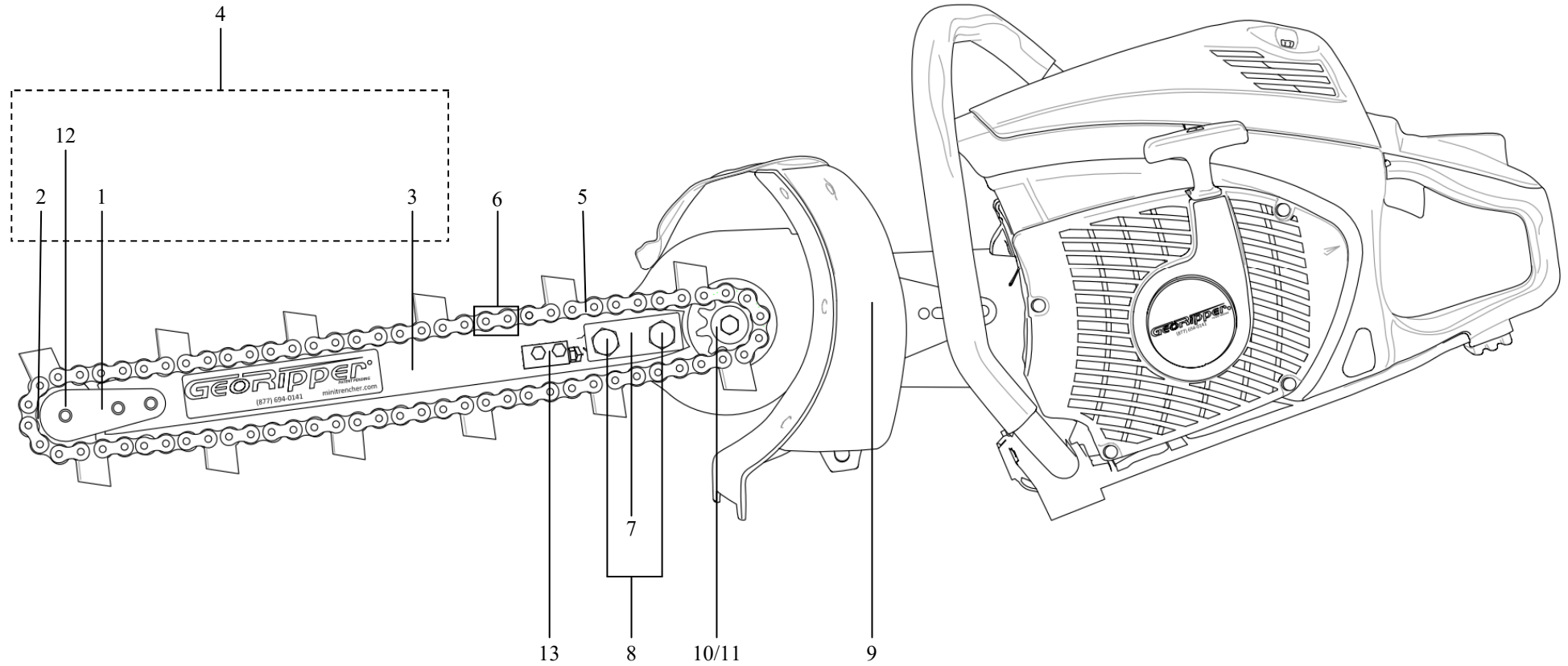







GeoRipper Schiene komplett, zwei selbstscharfende Grabketten (38mm), Motor-Anbausatz, Ersatzlager Umlenkstern, Montageschlüssel, Bedienungsanleitung, Husqvarna Antriebsmotor mit Eratzantriebsriemen

Artikel Nr	Bezeichnung	Gewicht kg
K770 GR16	GR16 mit Husqvarna K770	16,00
K770 GR20	GR20 mit Husqvarna K770	16,60
K970 GR20	GR20 mit Husqvarna K970 MK3	18,00
K970 GR27	GR27 mit Husqvarna K970 MK3	20,00













# Ersatzteile

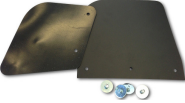

Nr	Artikel Nr	Bezeichnung	Abbildung	Gewicht kg
1	GR1	Schienen spitze		0,26
2	GR2	Umlenkstern 6 Zahn GR16, GR20		0,10
	GR2-11	Umlenkstern 11 Zahn GR27		0,10
3	GR3-16	Schiene 400mm einzeln		0,94
	GR3-20	Schiene 500mm einzeln		1,23
	GR3-27	Schiene 700mm einzeln		2,11
4	GR3C-16	Schiene 400mm komplett		1,30
	GR3C-20	Schiene 500mm komplett		1,59
	GR3C-27	Schiene 700mm komplett		2,47
5	GR4-16	Kette 400x38mm (2 Stück)		3,00
	GR4-16-1	Kette 400x25mm (2 Stück)		3,00
	GR4-16-W	Kette 400x60mm (1 Stück)		1,60
	GR4-20	Kette 500x38mm (2 Stück)		3,50
	GR4-20-1	Kette 500x25mm (2 Stück)		3,50
	GR4-20-W	Kette 500x60mm (1 Stück)		2,00
	GR4-27	Kette 700x38mm (2 Stück)		5,00
	GR4-27-1	Kette 700x25mm (2 Stück)		5,00

# Ersatzteile



Nr	Artikel Nr	Bezeichnung	Abbildung	Gewicht kg
6	GRCL	Kettenverbinder		0,01
7	GR6	Klemmplatte Schiene		0,08
8	GR7	Schraube mit Scheibe (2 Stück)		0,09
9	GR8	Spritzschutz		
10	GRP-6102	Ritzel 9 Zahn EK6101 PC6114		0,09
	GRP-7602	Ritzel 9 Zahn EK7651 EK 8100 PC 7651 PC 8216		0,09
	GRPH-7602 RING	Ritzel 9 Zahn K760 K770 K970 MK3		0,09
	GRPS-90	Ritzel 9 Zahn TS700		0,09
11	GRP-SD	Messingbolzen Stihl (2 Stück)		0,01
12	GRP-NB	Umlenksternlager		0,03
13	GRP-CT	Kettenspanner (Nur bei GR27 verbaut)		

# Ersatzteile EZ-Kart



Nr	Artikel Nr	Bezeichnung	Abbildung	Gewicht kg
	GRPEZ-02	EZ Kart Griff		
	GRPEZ-04	EZ Kart Gashebel		0,09
	GRPEZ-06	EZ Kart Gestänge		
	GRPEZ-08	EZ Kart Gaszug		0,11
	GRPEZ-10H	EZ Kart Gasbetätigung Husqvarna		
	GRPEZ-10M-6100-8100	EZ Kart Gasbetätigung EK6101 EK8100		
	GRPEZ-10M-7651H	EZ Kart Gasbetätigung EK 7651		
	GRPEZ-10S	EZ Kart Gasbetätigung Stihl		
	GRPEZ-12	EZ Kart Clip		
	GRPEZ-14	EZ Kart Unterlegscheibe & Clip		
	GRPEZ-16	EZ Kart Räder (2 Stück)		
	GRPEZ-18	EZ Kart Gurt		
	GRPEZ-20	EZ Kart Schnalle		
	GRPEZ-26	EZ Kart Achsverlängerung		
	GRPEZ-27	EZ Kart Achsverlängerung Clip		
	GRPEZ-28	EZ Kart Steinschutz		1,25